

D-150A II

POWER AMPLIFIER

OWNER'S MANUAL



Applies only to 120 VAC
North American units.

©1994 by CROWN INTERNATIONAL, INC.
P.O. Box 1000, Elkhart, IN 46515
Telephone: 219-294-8000



Printed on
recycled paper.

Trademark Notice: Amcron®, Crown®, and IOC® are registered
trademarks of Crown International, Inc.

K80001C3
7/94

The information furnished in this manual does not include all of the details of design, production, or variations of the equipment. Nor does it cover every possible situation which may arise during installation, operation or maintenance. If your unit bears the name "Amcron," please substitute it for the name "Crown" in this manual. If you need special assistance beyond the scope of this manual, please contact our Technical Support Group.

Crown Audio Division Technical Support Group

57620 C.R. 105, Elkhart, Indiana 46517 USA

Phone: 800-342-6939 (U.S.A.) or 219-294-8200 Fax: 219-294-8301



WARNING

TO REDUCE THE RISK OF ELECTRIC SHOCK, DO NOT EXPOSE THIS EQUIPMENT TO RAIN OR MOISTURE!

CAUTION

**RISK OF ELECTRIC SHOCK
DO NOT OPEN**

TO PREVENT ELECTRIC SHOCK DO NOT OPEN. NO USER SERVICEABLE PARTS INSIDE. REFER SERVICING TO QUALIFIED SERVICE PERSONNEL.

AVIS

**RISQUE DE CHOC ÉLECTRIQUE
N'OUVREZ PAS**

À PRÉVENIR LE CHOC ÉLECTRIQUE NE PAS OUVRIR. RIEN DES PARTIES UTILES À L'INTÉRIEUR.

CONTENTS

1	Welcome	1-1
	1.1 Unpacking	1-1
	1.2 Features	1-1
2	Facilities	2-1
3	Installation	3-1
	3.1 Mounting	3-1
	3.2 Cooling	3-2
	3.3 Wiring	3-2
	3.3.1 Mode of Operation	3-2
	3.3.2 Input	3-3
	3.3.3 Output	3-4
	3.3.4 Load Protection	3-5
	3.3.5 Power	3-6
4	Operation	4-1
	4.1 Precautions	4-1
	4.2 Controls	4-1
	4.3 Protection	4-1
	4.4 Fuse Replacement	4-2
5	Service	5-1
	5.1 Worldwide Service	5-1
	5.2 North American Service	5-1
	5.2.1 Service at a North American Service Center	5-1
	5.2.2 Factory Service	5-1
6	Technical Information	6-1
	6.1 Principles of Operation	6-1
7	Specifications	7-1
	7.1 General	7-1
	7.2 Stereo	7-1
	7.3 Monaural	7-2
8	Options	8-1
	8.1 0.775 V Input Sensitivity	8-1
	8.1.1 Modification Instructions	8-1
	8.1.2 Specification Changes	8-1

ILLUSTRATIONS

1.1	D-150A II	1-1
2.1	Front and Rear Facilities	2-1
3.1	Stereo System Connection	3-1
3.2	Mounting Dimensions	3-1
3.3	Mono System Connection	3-2
3.4	Effect of Input Capacitor Value on Frequency Response	3-3
3.5	RFI Filters	3-4
3.6	Wire Size Nomograph	3-4
3.7	Connection to an Inductive Load	3-5
3.8	Loudspeaker Fuse Nomograph	3-5
3.9	AC Mains Voltage Conversion	3-6
6.1	Circuit Block Diagram	6-2
7.1	Power Matrix	7-2
7.2	Nominal Output Impedance	7-3
7.3	Nominal Output Phase Angle	7-3
7.4	Nominal Damping Factor	7-4
7.5	Nominal Phase Response	7-4
7.6	Nominal Crosstalk	7-5
7.7	Nominal Power Efficiency	7-5
7.8	Nominal Noise Spectrum	7-6
7.9	Nominal Frequency Response	7-6
8.1	Circuit Block Layout	8-1

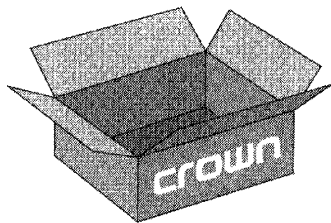

Fig. 1.1 D-150A II

1 Welcome

Thank you for purchasing the world-renowned D-150A II stereo power amplifier, a standard of audio excellence. Its high reliability, medium power output and cost efficiency make it an ideal amp for auditoriums, churches and traveling sound companies. Its ultra-low distortion and advanced AB+B circuitry qualify it for recording studios — wherever critical listening is required. The D-150A II is completely compatible with its predecessor, the D-150A, allowing it to integrate easily into existing sound systems. We construct each unit carefully from the finest materials and back each one with a full three-year warranty.

In order to enjoy your D-150A II to the fullest, we strongly recommend you read all the instructions, warnings and cautions contained in this manual. And for your protection, please send in your warranty registration card today and save your bill of sale as it is your official proof of purchase. Happy listening!



1.1 Unpacking

Please unpack and inspect your new D-150A II amplifier for any damage that may have occurred during transit. If any damage is found, notify the transportation company immediately. Only you, the consignee, may initiate a claim with the carrier for damage resulting during shipment. Crown will be happy to cooperate fully as needed. Save

the shipping carton as evidence of damage for the carrier's inspection.

Even if the unit arrived in perfect condition, as most do, save all packing materials so you will have them if you ever need to transport the unit. **NEVER SHIP THE UNIT WITHOUT THE FACTORY PACK.**

You should find the following items when you unpack:

- D-150A II amplifier
- 2 Dual Banana Plugs
- 4 Nylon Washers
- 4 10-32 Trusshead 1/2" Black Screws
- This Owner's Manual

1.2 Features

Here are some of the exciting features you will find in your new D-150A II power amplifier:

- Advanced AB+B class circuitry yielding maximum efficiency with minimum "crossover notch" distortion.
- Ultra-low harmonic and I.M. distortion resulting in best *dynamic transfer function* in industry.
- Very low noise level and wide dynamic range exceed digital audio standards.
- High damping factor giving greater motion control of loudspeakers.
- Patented IOC® (Input/Output Comparitor) circuitry immediately alerts of any distortion exceeding 0.05%, providing proof of performance.
- Outputs can be configured in "bridge-mono" mode for higher-power single-channel operation.
- Two regulated power supplies give complete isolation and stability.
- Passive cooling system uses integrated heatsink/chassis design for maintenance-free long-life operation.
- Rack mountable in a standard 19 inch equipment rack.

2 Facilities

A. Power

Depress this push button to turn on or off the D-150A II. Turn-on is instantaneous, with minimum thumps and no program delay. Because there is no delay, always turn on the D-150A II last so that turn-on transients from other components feeding the amplifier (like a mixer) will not be amplified.

B. Power Indicator

A LED that glows while the D-150A II is on.

C. Output Jacks

Banana jacks are provided at the output of each channel. Install banana plugs on the speaker cables for connection to the output jacks (bare wire or spade lugs may also be used). In MONO mode, only the two outside jacks (red) are used.

D. Input Jacks

An unbalanced 1/4 inch phone jack is provided for input to each channel. Do not use the Channel 2 input in MONO mode.

E. Stereo/Mono Switch

Facing the back of the amplifier, slide this switch to the left for STEREO mode and to the right for MONO mode. In MONO mode the input and level control for Channel 2 should not be used and only balanced (ungrounded) loads should be connected to the output jacks. (See wiring instructions in Section 3.3.)

F. Fuse

The AC line is safely fused. If the unit is configured for 100 or 120 VAC, an MDX-type 6.25 amp fuse is used. If the unit is set to use 200, 220 or 240 VAC, an MDA-type 3 amp fuse is used. Using of any other fuse size or type will invalidate the warranty.

G. Power Cord

A standard three-wire grounded AC cord and plug are provided.

H. Level

The volume of each channel is independently controlled by these level controls. The control for Channel 2 should be turned completely down and not used when operating in MONO mode.

I. IOC

An Input/Output Comparator LED is provided for each channel. The IOC indicators will flash or glow when distortion of any kind exceeds 0.05%. It is normal for them to glow for about a minute when the amplifier is turned off.

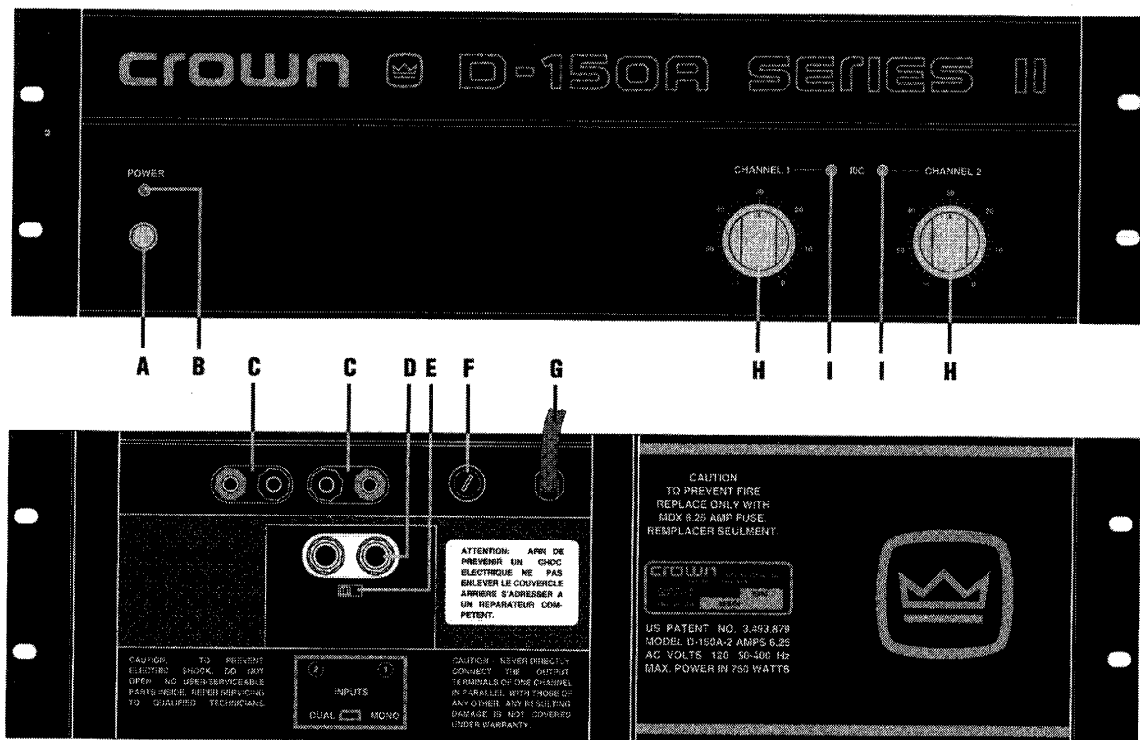

Fig. 2.1 Front and Rear Facilities

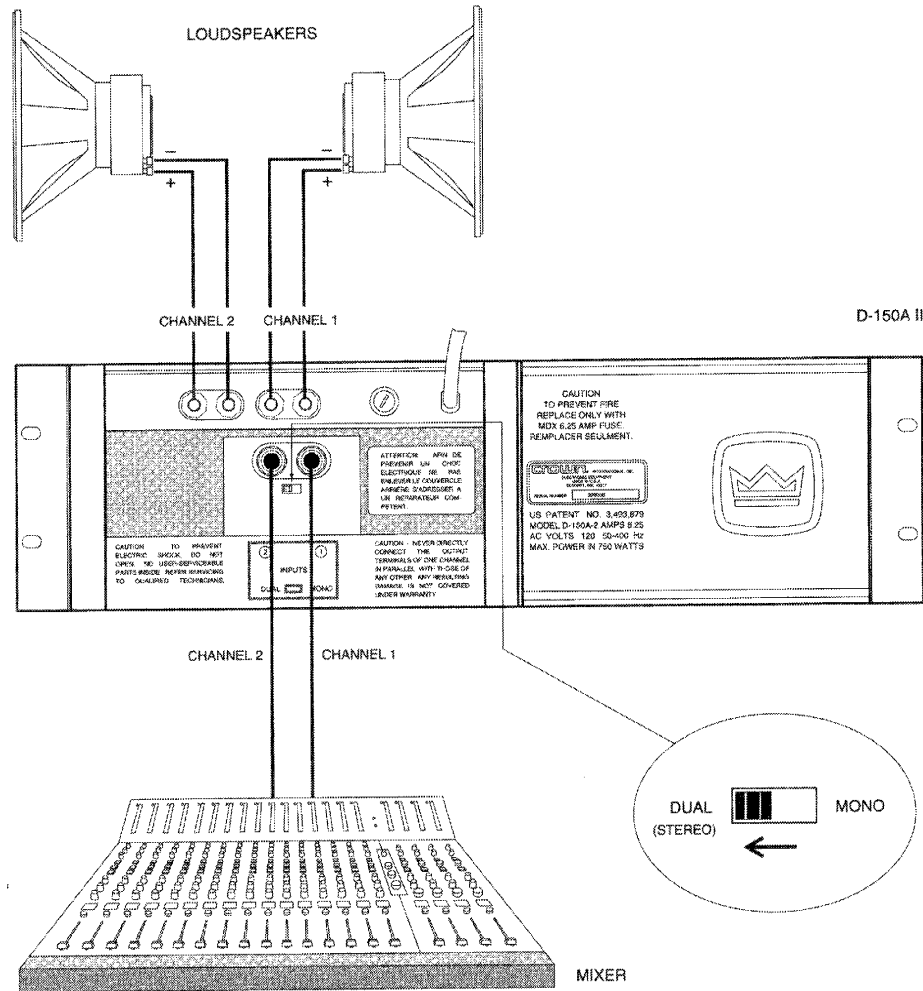

Fig. 3.1 Stereo System Connection

3 Installation

Before beginning the installation of your amplifier, please carefully note the following: *It is always wise to remove power from the unit and turn the input level controls off while making connections*—especially if the load is a loudspeaker system. This will eliminate any chance of loud blasts or damage to the loudspeakers.

3.1 Mounting

The D-150A II can be mounted into a standard 19 inch equipment rack or a custom cabinet of your own design. It occupies 5.25 inches of vertical rack space. The equipment rack or cabinet should have perforated panels in the top and bottom for ventilation. This is especially important if more than one amplifier will be mounted in the same cabinet. Please consider the cooling requirements.

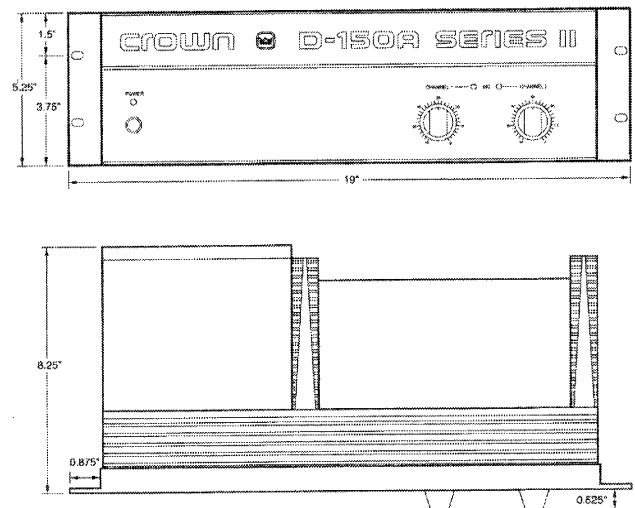

Fig. 3.2 Mounting Dimensions

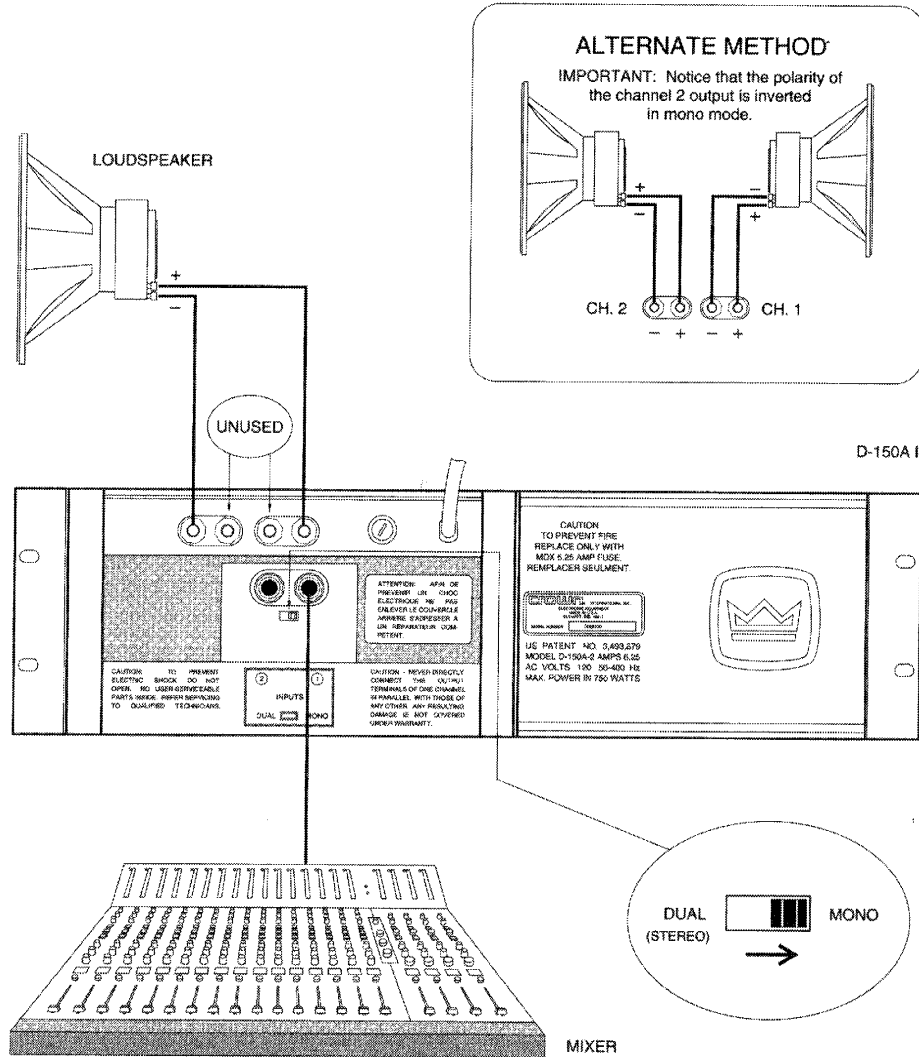

Fig. 3.3 Mono System Connection

3.2 Cooling

Sufficient ventilation must be provided in order to prevent overheating. Applications requiring long, sustained use at high power levels may require you to add a cooling fan. When rack mounting, we recommend that you allow a 1.75 inch space above and below the unit.

3.3 Wiring

Figures 3.1 and 3.3 depict the two most common ways to install a D-150A II in a sound system. All input and output jacks are located on the rear panel. Please use care in making connections, selecting signal sources and controlling the output level. The load you save may be your own! Crown is not liable for any damage done to loads due to careless amplifier usage and deliberate overpowering.

3.3.1 Mode of Operation

The D-150A II may be operated in either STEREO (Dual

or two-channel) or MONO mode by switching the Stereo/Mono switch on the rear panel of the amplifier. There are VERY IMPORTANT wiring differences between these two modes which are discussed next.

STEREO

The installation is very intuitive in STEREO mode. The input of Channel 1 feeds the output of the same channel as does the input of Channel 2. To put the amplifier in stereo mode, slide the Stereo/Mono switch at the back of the amplifier toward the left (as you face the rear of the amp). Be very careful not to short the two outputs together while in STEREO mode and observe correct loudspeaker polarity.

CAUTION: Never parallel the two outputs by directly tying them together or parallel them with the output of any other amplifier. Such connection does not result in increased power output and can cause excessive heating.

MONO

Installing the amplifier in MONO mode is very different. MONO mode is activated when the Stereo/Mono switch is pushed toward the right (as you face the rear of the amp). In this mode only the Channel 1 input should be used. **DO NOT USE THE CHANNEL 2 INPUT** or signal level and quality may be greatly degraded. Keep the Level control of Channel 2 turned completely down.

Note: The input jack and Level control of Channel 2 are not defeated in MONO mode. Any signal fed into Channel 2 will beat against the signal in Channel 1.

The output wiring is very different, too. The polarity of the output of Channel 2 is inverted so it can be bridged with the output of Channel 1. The outputs of both channels receive the same signal from the input of Channel 1. This results in two possible monaural output configurations (see Figure 3.3).

The first and most common configuration connects the positive lead from the loudspeaker to the red post of Channel 1 and the negative lead to the red post of Channel 2 (the inner black posts are not used). This method is called "bridge-mono." It produces the highest power output as indicated in Section 7.3 of the Specifications.

The second configuration connects a loudspeaker to the output of each channel separately. Remember that since the amplifier is in MONO mode, the output of Channel 2 is inverted. To compensate for this, reverse the connections to Channel 2 so that the positive lead from the loudspeaker goes to the black post and the negative lead to the red post. The output of Channel 1 is not inverted so the loudspeaker connected to it is wired in the normal fashion with its positive lead attaching to the red post.

CAUTION: Be certain that all equipment (meters, switches, etc.) connected to the MONO output lines is balanced. Both sides of the line must be totally isolated from the input grounds. If this is not strictly observed, severe oscillation may result.

3.3.2 Input

The inputs are unbalanced, have a nominal impedance of 25 K ohms and will accept most line-level outputs.

Input Wiring Tips

1. Use only shielded cable. The higher the density of the shield (the outer conductor), the better the cable. Spiral wrapped shield is not recommended.
2. Keep the cables as short as possible. Avoid cable lengths greater than 10 feet (3 meters). Long unbalanced cables may degrade high frequencies are more likely to experience interference from nearby components.
3. Do not run signal cables together with high-level wiring such as loudspeaker wires or AC cords. (This lessens the chance of hum or noise being induced into the input cables.)
4. Turn the entire system off before changing any connections, and turn the level controls down before powering the system up. Crown is not liable for damage incurred when any transducer or component is overdriven.

Large subsonic (subaudible) frequencies are sometimes present in the input signal and can overload, overheat or otherwise damage loudspeakers. To remove such frequencies (and any unwanted DC that may also be present), place a capacitor in series in the input signal line. The graph in Figure 3.4 shows how the value of the capacitor affects the frequency response. Use only a low-leakage paper, mylar or tantalum capacitor.

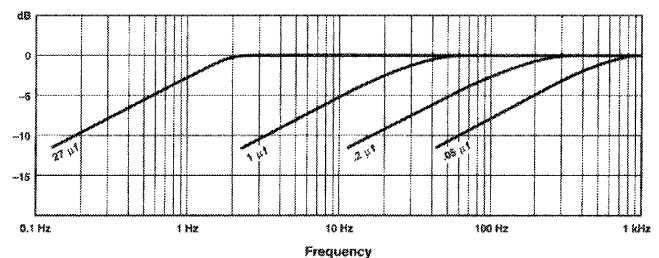

Fig. 3.4 Effect of Input Capacitor Value on Frequency Response

If large amounts of ultrasonic or RF (radio frequency) are found on the input, such as bias from tape recorders, etc., place a low-pass filter on the input. While the highest RF levels that can be reasonably expected may not damage the amplifier, they can burn out tweeters or other sensitive loads, activate the amplifier's protective system or overload the controlled-slewing-rate stage of the amp. (This latter amp stage provides RF overload protection.) The following filters are recommended for such situations:

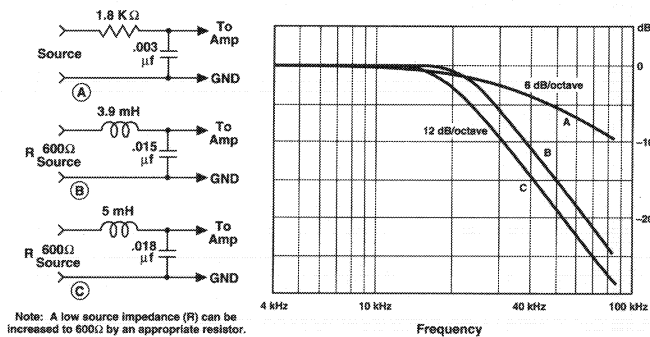

Fig. 3.5 RFI Filters

Another problem to prevent is ground loops—undesirable currents flowing in a grounded system, possibly causing hum in the output. A common form of loop is a pair of input cables whose area is subjected to a magnetic hum field. To prevent ground loops causing magnetic induction, lace both cables together along their length, and away from the power transformer. **DO NOT CONNECT THE INPUT AND OUTPUT GROUNDS TOGETHER.**

Yet another facet of this problem occurs when input and output grounds, tied together as in testing or metering, allow feedback oscillation from load current flowing in the loop. In some systems, even the AC power line may provide this feedback path. Proper grounding, isolation of inputs and common AC-line devices is good practice.

3.3.3 Output

Consider the power handling capacity of your load before connecting it to the amplifier. Crown is not liable for damage incurred when a transducer or other component is overdriven. The use of loudspeaker protection fuses is highly recommended (see Section 3.3.4). Also, please read the Operating Precautions section (Section 4.1).

Use loudspeaker cables of sufficient gauge (thickness) for the length used. Otherwise, power is lost through cable heating and the damping factor decreased due to cable resistance. Refer to the nomograph following for recommended wire size (Figure 3.6). If dynamic moving-coil loudspeakers are used, find R_L by measuring the resistance of the voice coil with an ohmmeter. If electrostatic loud-

speakers are used, use the rated nominal impedance of the manufacturer for R_L .

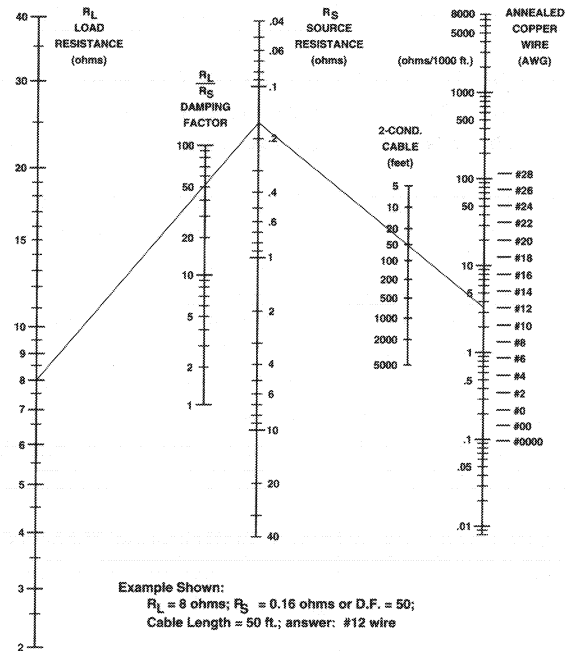

Fig. 3.6 Wire Size Nomograph

Use the nomograph as follows:

1. Note the load resistance of the speakers connected to each channel of the amplifier. Mark this value on the nomograph "Load Resistance" line.
2. Choose an acceptable system damping factor (50 is typical). Mark this value on the "Damping Factor" line.
3. Draw a pencil line through these two points, intersecting the "Source Resistance" line.
4. On the "2-Cond. Cable" line, mark the length of cable run.
5. Draw a pencil line from the intersection point on the "Source Resistance" line through the mark on the "2-Cond. Cable" line.
6. Note where the pencil line intersects the "Annealed Copper Wire" line. The value is the required gauge of loudspeaker cable.
7. If the size of cable exceeds what you want to use, settle for a lower damping factor and try again or use more than one cable for each line. A "rule of thumb" for the latter choice is: Every time you double the number of conductors (of equal gauge) the resulting apparent gauge is three less. For example, you determine that you need #10 AWG wire but this is too large, so you decide instead to use two #13 AWG wires in place of each #10 wire and achieve the same affect. In this same example you could also substitute four #16 AWG wires.

To prevent high-frequency oscillations:

1. Lace the loudspeaker cables together.
2. Keep the loudspeaker cables well separated from the input cables.
3. Never connect the amplifier's input and output grounds together.
4. As a last resort, install a lowpass filter on the signal input line (see preceding Input section).

Use Good Connectors

1. Male connectors on speaker cables should not be exposed to prevent possible short circuits.
2. Connectors which might accidentally cause the two channels to be tied together during making and breaking of connections should not be used. (A common example is the standard 3-wire ¼ inch stereo phone plug.)
3. Connectors which can be plugged into AC power receptacles should never be used.
4. Connectors having low-current-carrying capacity should not be used.
5. Connectors having any tendency to short, or having shorted leads should never be used.

TRANSFORMER COUPLING

Loads that are primarily inductive such as 70 V step-up transformers and electrostatic loudspeakers require special attention. To prevent large low-frequency currents from damaging the transformer (and prevent the D-150A II from unnecessarily activating its protective system) it may be necessary to install a capacitor in series with the load. If you are unsure whether this is necessary, measure the DC resistance across the terminals of each load with an ohmmeter. If the resistance you measure is less than 3 ohms either add the following parts as illustrated in Figure 3.7 or add an appropriate high-pass filter.

Place an external non-polarized capacitor of 590 to 708 μF and a 4 ohm power resistor in series with the positive (+) lead as shown below:

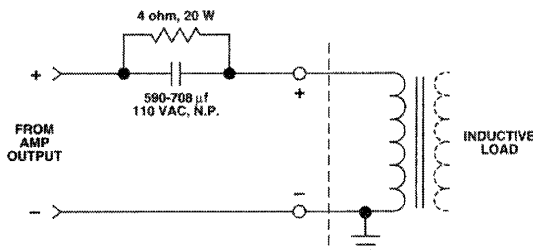

Fig. 3.7 Connection to an Inductive Load

3.3.4 Load Protection

We recommend that you protect your loudspeakers (or other sensitive loads) from damage resulting from excessive power. A common way to do this is to put a fuse in series with the load. A single fuse may be used for the entire system, or each driver may be fused.

Fuses help prevent damage due to prolonged overload, but provide essentially no protection against damage from large transients. To minimize this problem, use high-speed instrument fuses such as the Littlefuse 361000 series. Figure 3.8 is a nomograph showing fuse size versus loudspeaker peak power ratings. If, on the other hand, the loudspeaker is only susceptible to damage caused by overheating, use a fuse or circuit breaker having the same slow thermal response as the loudspeaker itself (such as a slow-blow fuse).

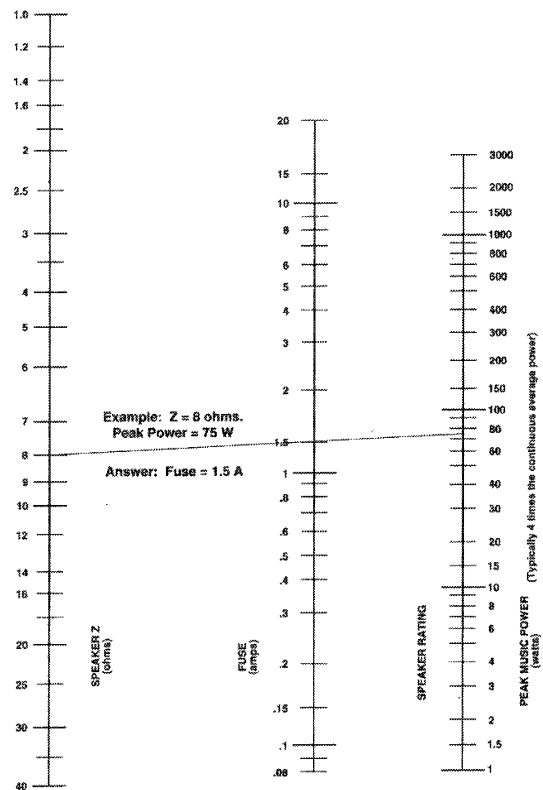

Fig. 3.8 Loudspeaker Fuse Nomograph

3.3.5 Power

A standard three wire (grounded) AC plug is provided with the amplifier. Adapters are commercially available for adapting to a two wire system if necessary.

Note: Crown assumes no liability whatsoever for ungrounded operation, nor for violation of UL or local electrical codes.

Five standard line-voltage connections are offered: 100, 120, 200, 220 and 240 VAC. Only a competent technician should attempt to alter the line voltage configuration. The tag attached to the line cord indicates the voltage for which the amplifier is connected. Most units are connected for 120 VAC. For operation of another line voltage, the unit must be converted in the following manner:

1. Turn the D-150A II off and disconnect it from any power source.
2. Remove the two rack ears from the front panel (4 socket cap screws).
3. Remove the front panel (6 screws).
4. Position the front panel to gain access to the power transformer leads. Locate the two terminal strips to which the transformer connects (terminals A, B, C, D, E).
5. Determine the correct connections from the following diagram (Figure 3.9), unsolder the leads that need to be moved and solder them in their new positions.
6. Carefully check all connections and repeat steps 2 and 3 in reverse order to reassemble the amplifier.
7. Check to be sure the proper fuse is installed in the rear panel. Install the correct one if necessary.

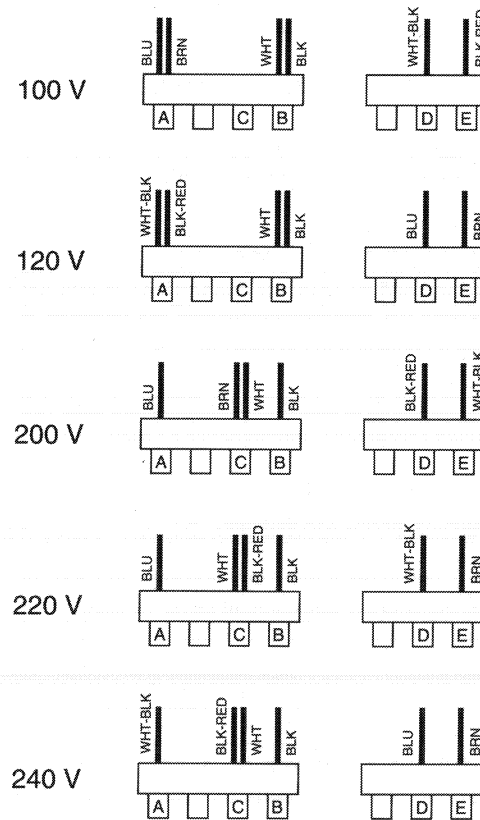

Fig. 3.9 AC Mains Voltage Conversion

Note: Use only a 6.25 amp MDX-type fuse for 100 or 120 VAC operation. Use only a 3 amp MDA-type fuse for 200, 220 or 240 VAC operation.

4 Operation

4.1 Precautions

Although your amplifier is well protected from any external faults, we recommend the following precautions be taken for safe operation:

1. When using input sources of uncertain level or any audio components which have not previously been used with your amplifier, always begin with the level controls at a minimum and gradually increase them while monitoring the audio output level to avoid suddenly blasting the loudspeakers.
2. Don't forget that the D-150A II has no turn on delay. Beware of turn-on transients from other equipment ahead of the amp—always turn the amp on last after the other equipment has stabilized.
3. Turn the amplifier off and unplug it from the AC line before replacing the fuse. (The unit must be totally disconnected from the AC power source because the fuse socket is still powered even when the unit is turned off.)
4. Operate the amplifier with the correct fuse (6.25 amp MDX-type for 100 or 120 VAC; 3 amp MDA-type for 200, 220 or 240 VAC).
5. Never drive a transformer-coupled device (such as an electrostatic loudspeaker) or any other device which appears as a low-frequency short (less than 3 ohms) without a series isolating capacitor. Such operation may damage the load and/or needlessly activate the amplifier's VI limiting.
6. Operate the amplifier from AC mains of not more than 10% above the selected line voltage and only the specified line frequency (50, 60 or 400 Hz). Failure to comply with these limits will invalidate the warranty.
7. Never connect the output to a power supply output, battery, or power main. Damage incurred by such a hookup is not covered by the warranty.
8. Do not expose the amplifier to corrosive chemicals such as soft drinks, lye, salt water, etc.
9. Do not tamper with the circuitry. Circuit changes made by unauthorized personnel, or unauthorized circuit modifications, will invalidate the warranty.

4.2 Controls

Independent level controls, a power switch and a power indicator are located on the front panel. Both level controls are used in STEREO mode, but only the Channel 1 control is used in MONO mode. They are used to adjust the desired output level. The amplifier gain is 26 dB as determined by 1% precision resistors in the feedback loop.

The operation mode is switched between STEREO and MONO by the Stereo/Mono switch located on the back panel. Also located on the back panel is an AC line fuse.

In addition to the above essential controls, your high-performance amplifier has an IOC (Input/Output Comparator) indicator for each channel. These red LEDs are located on the front panel above the level controls. They will flash or glow whenever the distortion specifications of the amplifier are being exceeded. (It is normal for them to glow for about one minute after the AC power is turned off.)

4.3 Protection

The D-150A II is protected against all the common hazards which plague high-powered amplifiers, including: shorted, open and mismatched loads; overloaded power supplies; excessive temperature; chain destruction phenomena; input overload damage; and, high frequency overload blowups.

Protection against shorted and low impedance loads is provided by the Signal Programmed Automatic Current Executor (SPACE control). It functions as an automatic current limiter at audio frequencies whose current limiting threshold is dependent on the history of the output signal. Output current causes the threshold to increase. The no-signal threshold is high enough to allow tone bursting (even into 4 ohms) without premature limiting, as is found in some recent products of other manufacturers.

Since the limiter has no instantaneous response to output voltage, flyback transients do not appear in the output when limiting occurs on inductive loads. (Flyback transients are a normal by-product of VI limiting, also called "Energy Limiter," with an inductive load. The amplifier yields to the inductive load which causes the load to emanate a pulse. This returned inductive energy has the opposite polarity or the original pulse—hence the name "flyback" pulse. It results in a rasping, popping distortion which is very irritating.)

Because the current limiter of the D-150A II will not yield to the constant current demands of an inductive load but will sustain them, it is immune to flyback distortion.

Early amplifier designs frequently employed fixed current limiters, reducing flyback transients, but had serious difficulty obtaining reliable low frequency output—especially at full-voltage into 4 ohm loads. In addition, many early designs used fragile epi-base or triple-diffused outputs which mated poorly to the current limiting protection schemes used and resulted in low performance. The D-150A II uses two multiple epitaxial silicon power transistors per channel. Their toughness allows the reliable use of a current limiter. And since the SPACE control adjusts the

limiting to the spectral content of the signal, much larger power outputs are safely achieved.

At subsonic frequencies, the SPACE control behaves as a VI limiter and provides the increased protection needed at DC to prevent destruction due to excessive heat build-up in the half of the output stage that is being driven.

The AC line for 100 or 120 V is fused with a 6.25 A, type MDX fuse. For 200, 220 or 240 VAC, a 3 A type MDA fuse is used. The use of any other type or size fuse will invalidate the warranty.

On the chassis is mounted a thermal switch which protects the amplifier against insufficient ventilation. If it becomes too hot, the AC line power will be interrupted until the temperature falls to a safe level, whereupon power will automatically be restored. When such an event occurs the external symptoms are: no output and a warm amplifier.

All the amplifier's voltage-amplifier circuitry is designed to be inherently current-limited. Thereby, if any of the devices should fail (which is extremely unlikely) no damage will occur to the rest of the stages.

The input stage is protected against excessive input signal level (overdrive) by a series-limiting resistor.

The amplifier features a controlled slew rate which, coupled with the SPACE controller, protects the amplifier from blowups when fed large RF input signals.

4.4 Fuse Replacement

An AC line fuse is located next to the power cord on the back panel of the amplifier. To replace the fuse, first **TURN OFF THE POWER AND DISCONNECT THE POWER PLUG FROM THE POWER SOURCE.** Unscrew the cap of the fuse holder and remove the fuse.

Replace the fuse with a 6.25 amp MDX-type fuse for 100 or 120 VAC operation and a 3 amp MDA-type fuse for 200, 220 or 240 VAC operation. Reassemble in reverse order.

IMPORTANT: The fuse holder still has power even when the power switch is turned off. **ALWAYS DISCONNECT AC POWER BEFORE REPLACING FUSES.**

5 Service

This unit has very sophisticated circuitry which should only be serviced by a fully trained technician. This is one reason why each unit bears the following label:

CAUTION: TO PREVENT ELECTRIC SHOCK DO NOT REMOVE COVERS. NO USER SERVICEABLE PARTS INSIDE. REFER SERVICING TO A QUALIFIED TECHNICIAN.

5.1 Worldwide Service

Service may be obtained from an authorized service center. (Contact your local Crown/Amcron representative or our office for a list of authorized service centers.) To obtain service, simply present the bill of sale as proof of purchase along with the defective unit to an authorized service center. They will handle the necessary paperwork and repair.

Remember to transport your unit in the original factory pack. We will pay the surface shipping costs both ways **for warranty service** to the authorized service center nearest to you after receiving copies of all shipping receipts. You must bear the expense of all taxes, duties, and customs fees when transporting the unit.

5.2 North American Service

Service may be obtained in one of two ways: from an authorized service center or from the factory. You may choose either. It is important that you have your copy of the bill of sale as your proof of purchase.

5.2.1 Service at a North American Service Center

This method usually saves the most time and effort. Simply present your bill of sale along with the defective unit to an authorized service center to obtain service. They will handle the necessary paperwork and repair. Remember to transport the unit in the original factory pack. A list of authorized service centers in your area can be obtained from our Technical Support Group.

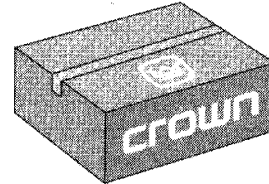

Always use the original factory pack to transport the unit.

5.2.2 Factory Service

To obtain factory service, fill out the *Service Information Card* in the back of this manual and send it along with proof of purchase and the defective unit to the Crown factory. Enclose a letter explaining the nature of the problem and what service you would like. Include your return shipping address and telephone number.

The unit must be shipped in the original factory pack. If you don't have the original shipping container, contact us and a replacement will be sent promptly.

Crown will pay ground shipping costs both ways in the United States **for warranty service** upon receiving copies of all shipping receipts. Shipments should be sent "UPS ground." (If the unit is under warranty, you may send it C.O.D. for the cost of shipping via UPS ground.) The factory will return the unit via UPS ground. Please contact us for other arrangements.

Crown Audio Division

Tech. Support / Factory Service
57620 County Road 105
Elkhart, Indiana 46517 U.S.A.

Phone: 1-219-294-8200

U.S.A.: 1-800-342-6939

Fax: 1-219-294-8301

6 Technical Information

The D-150A II has two totally direct-coupled amplifier circuits which employ a dual IC op-amp and silicon transistors in all stages. The circuit, designed and developed at Crown, represents a level of quality and performance unequaled in the field of audio amplifier design.

6.1 Principles of Operation

As is implicit in the term "totally direct-coupled," the D-150A II has a perfectly flat frequency and phase response extending from 20 kHz to 0 Hz or DC. Flat-to-DC response results in not only low frequency amplification with absolutely no phase-distortion, but also in perfect overload characteristics. Non-symmetrical waveforms (such as music) cause overload thumping in all currently produced AC amplifiers. These same amplifiers may, however, show no signs of thumping when fed a symmetrical test wave form such as a sinusoid. DC frequency response combined with ultra-low noise and IM distortion results in the closest approach to a "straight wire with gain."

Another characteristic of a DC amplifier is the thump or pop produced at turn-on and turn-off. For example, at turn-on the input amplifier requires a finite period of time to reach operating levels. During this time the output could be driven to large DC offsets resulting in annoying thumps.

A supply voltage detector virtually eliminates this problem. The detector disconnects the regulated supply voltages to the output stages during these turn-on and turn-off periods, preventing the problem.

The dual IC op-amp is of a low noise type having a large gain bandwidth. The result of using it for the input voltage amplifier is that a maximum amount of feedback is applied, reducing distortion to phenomenally low values. This has been confirmed by measurement with an elaborate test setup employing Crown-developed solid state variable filters and wave analyzing equipment. No other available harmonic distortion test apparatus is capable of such low residuals. Distortion is kept to very low levels by employing multiple feedback loops to allow a maximum of total feedback.

The IOC (Input/Output Comparator) circuitry works in conjunction with the error correcting signal of the main op-amp. Any time a small "non-linearity" exists in the amplifier, an error signal appears at the output of the main op-amp (via the feedback loop of the unit). This produces an abnormally high value, exceeding the "window" of the IOC and illuminating the LED. Since transient overload can happen rapidly, a pulse stretching circuit is added so the eye

can detect the flash of the LED.

The lack of noise is evidenced by a typical 20 Hz to 20 kHz effective input noise of 1.25 μ volts which produces an effective 8 ohm output of 80 micromicro (pica) watts.

The output stage is a quasi-complementary format employing the Crown class AB+B technique which uses no bias current in the output transistors. The result is maximum efficiency with minimum crossover notch distortion and amplifier idling heat. Thus there is no bias current adjustment, as the output circuit is not temperature-tolerance critical. Temperature-related bias current drifts are further controlled by bias servos which are mounted on the heat sinks.

In the AB+B output circuit, the driver transistors carry the bias current, while the output transistors serve only as boosters. The output transistors sense when the driver transistors are delivering significant current to the load, take over, and deliver the large load currents.

Protection against shorted and low impedance loads is provided by the Crown-developed SPACE (Signal Programmed Automatic Current Executor) control circuit. It functions as an automatic current limiter at audible frequencies and as a VI limiter at subaudible frequencies. The threshold of current limiting is dependent on the history of the signal, yet the no-signal threshold of current limiting is high enough to allow full power tone bursting. The net result is total protection with a maximum of headache-free output power, requiring neither an inventory of special fuses or cumbersome load matching techniques.

The monolithic input amplifier stages result in extremely low DC drift. The input terminal bias current is offset by a unique temperature compensated source resulting in a laboratory amplifier needing no user-accessible offset controls.

The input amplifiers are powered by zener-regulated power supplies. The bias regulators are also powered by zener-regulated current sources with the result that line voltage variations do not cause noise or distortion due to misbiasing.

The power supply is a continuous-duty type. The main DC supplies are full-wave capacitor input type with heavy-duty, chassis heat-sinked diodes. Computer grade electrolytics furnish over 20 joules of energy storage. A higher voltage at low current is derived from a half-wave voltage-doubler circuit. This voltage is used in the amplifier's driver circuit.

The D-150A II represents nothing short of the highest quality in both circuitry and components. It should provide a lifetime of trouble-free service for the most discriminating users.

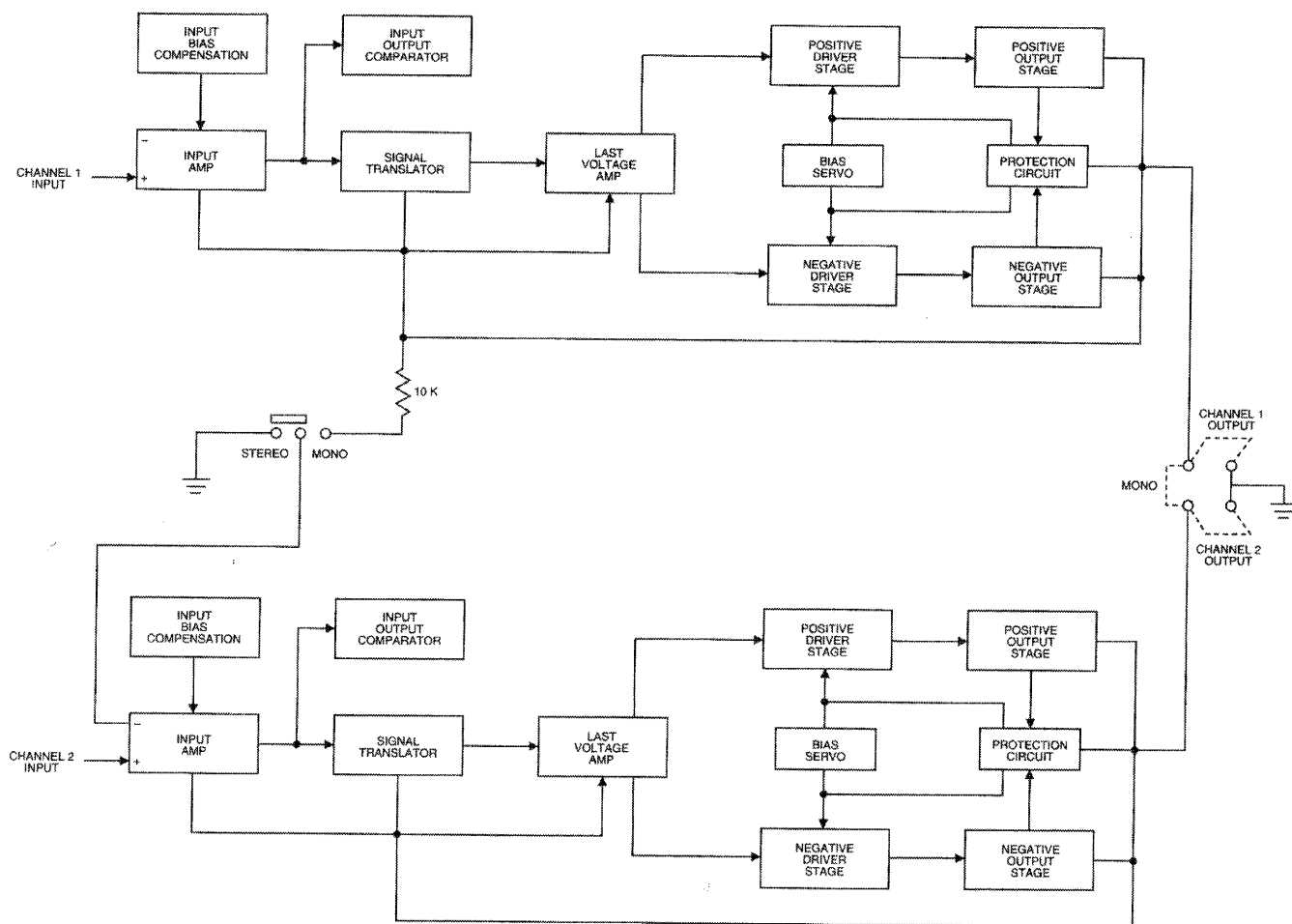

Fig. 6.1 Circuit Block Diagram

7 Specifications

Note: The following specifications apply to units in Stereo mode with 8 ohm loads and an input sensitivity of 26 dB gain unless otherwise specified.

7.1 General

Hum and Noise: (20 Hz to 20 kHz) 110 dB below rated output.

Phase Response: (DC to 15 kHz) +0/-15 degrees at 1 watt.

Input Impedance: 25 K ohm \pm 30%.

Amplifier Output Protection: Short, mismatch, and open circuit protection. Limiting is instantaneous with no flyback pulses, thumps or cutout. No premature limiting on transients.

Overall Protection: AC line fused. Thermal switch in AC line protects against overheating caused by insufficient ventilation. Controlled slew rate voltage amplifiers protect against RF burnouts. Input overload protection is furnished by internal resistance of amplifier inputs.

DC Output Offset: 10 millivolts or less (shorted input), internally adjustable to zero.

Turn-On: Instantaneous, with minimum thumps and no program delay.

Circuitry: Wideband multiple feedback loop design utilizing a linear IC (dual op-amp) equivalent to 48 transistors, 22 signal diodes, 3 zener diodes and 6 rectifier diodes.

Power Supply: Massive computer grade filter capacitors store over 20 joules of energy. Two regulated supplies for complete isolation and stability.

Power Requirements: Requires 100, 120, 200, 220 or 240 VAC (\pm 10%) at 50 to 400 Hz. Draws 30 watts or less at idle. Maximum AC power draw is 750 watts.

Heat Sinking: The entire amplifier is used as a heat sink, including the $\frac{3}{16}$ inch thick chassis and auxiliary fins.

Chassis: All aluminum construction for maximum heat conduction and minimum weight.

Controls: Independent level controls and power switch

with associated LED are located on the front panel. Non-interacting DC balance controls are mounted on main PC board under electronics cover. A Stereo/Mono switch is located below the input jacks on the rear panel.

Connectors:

Input: $\frac{1}{4}$ inch unbalanced phone jacks.

Output: Color coded binding posts (banana jacks).

AC Line: 3-wire NEMA 5-15 plug and 5 foot cable.

Dimensions: 19 inches (48.3 cm) long; 5 $\frac{1}{4}$ inches (13.3 cm) high; 8 $\frac{3}{4}$ inches (22.2 cm) deep from mounting surface on front panel.

Weight: 24 pounds (10.9 kg).

Finish: Polyester vinyl coated front panel with Lexan overlay.

7.2 Stereo

Output Power: 80 watts per channel minimum RMS (both channels driven) from 1 Hz to 20 kHz at 0.05% THD (also see Figure 7.1).

Frequency Response: \pm 0.1 dB from DC to 20 kHz at 1 watt; \pm 1 dB from DC to 100 kHz.

1 kHz Power: 90 watts RMS per channel with both channels driven and 0.1% THD.

Total Harmonic Distortion (THD): Less than 0.001% from 20 to 400 Hz and increasing linearly to 0.05% at 20 kHz with rated output.

IM Distortion: (S.M.P.T.E. 60 Hz to 7 kHz 4:1) Less than 0.05% per channel from 0.01 to 0.25 watts and less than 0.01% per channel from 0.25 to 80 watts.

Slew Rate: 6 volts per microsecond.

Damping Factor: Greater than 400 from DC to 400 Hz.

Output Impedance: Less than 15 milliohms in series with less than 3 microhenries.

Load Impedance: Rated for 8 ohm usage; safely drives any load, including completely reactive loads.

Voltage Gain: 20.6:1 \pm 2% or 26.3 dB \pm 0.2 dB at maximum gain.

Input Sensitivity: 1.19 volts \pm 2% at rated output.

Output Signal: Unbalanced, dual channel.

7.3 Monaural

Output Power: 160 watts minimum RMS into 16 ohms from 1 Hz to 20 kHz at 0.05% THD (also refer to Figure 7.1).

Frequency Response: ± 0.15 dB from DC to 20 kHz at 1 watt (referenced to 1 kHz) into 16 ohms; ± 1 dB from DC to 60 kHz.

Harmonic Distortion: Less than 0.001% from 20 to 400 Hz and increasing linearly to 0.05% at 20 kHz (160 watts into 16 ohms).

IM Distortion: (S.M.P.T.E. 60 Hz to 7 kHz 4:1) Less than 0.05% from 0.01 to 0.25 watts and less than 0.01% from 0.25 to 160 watts into 16 ohms.

Slew Rate: 12 volts per microsecond.

Damping Factor: Greater than 400 from DC to 400 Hz into 16 ohms.

Output Impedance: Less than 30 milliohms in series with less than 6 microhenries.

Load Impedance: Rated for 16 ohm usage; safely drives any load, including completely reactive loads.

Voltage Gain: 41.2:1 $\pm 2\%$ or 32.3 dB ± 0.2 dB at maximum gain.

Input Sensitivity: 1.19 volts $\pm 2\%$ at 160 watts into 16 ohms.

Output Signal: Balanced, single channel.

D-150A II											
Configuration & Load (ohms)	FTC Continuous Average Power at 0.1% THD (See note 1)		Max Average Power at 0.1% THD (See note 2)	Single Cycle Tone Burst Watts at <0.05% THD (See note 3)			40 ms Tone Burst Watts at <0.05% THD (See note 4)			EIA Watts at 1% THD (See note 5)	
	20Hz-20kHz	1 kHz		1 kHz	20 Hz	50 Hz	1 kHz	20 Hz	50 Hz		1 kHz
Stereo (both channels powered)	4	125	145	155	115	160	205	115	150	145	160
	8	80	90	95	75	95	110	75	90	85	95
	16	50	50	50	45	50	55	45	50	50	55
Bridge-Mono (balanced output)	8	250	295	315	285	340	415	285	315	300	320
	16	160	180	185	185	195	215	185	185	180	195

Fig. 7.1 Power Matrix (120 VAC, 60 Hz)

Power Specifications

Many manufacturers publish power specifications with a tolerance of ± 1 dB or worse. That means their amplifier can deviate more than 20% in output! A 100 watt amp would meet their spec if it only produced 79.4 watts. Other manufacturers qualify their specs by saying they are "typical" or "subject to manufacturing tolerances," thereby removing any performance guarantee. We take a different approach at Crown—our published specifications are *guaranteed* for three years and can be protected with *Service Plus* for an additional 3 years. Further, because our "in-house" specs are more stringent than our published specs, every Crown amplifier will exceed its published specs. We believe you should get what you pay for.

Notes:

1. Continuous power in the context of Federal Trade Commission testing is understood to be a minimum of five minutes of operation. Harmonic distortion is measured at the RMS sum total as a percentage of the fundamental output voltage. This applies for all wattages greater than 0.25 watts.
2. A 1 kHz sine wave is presented to the amplifier and the output monitored for non-linear distortion. The level is increased until the THD reaches 0.1%. At this level the average power per channel is reported.
3. A single cycle of sine wave is presented to the amplifier and monitored for non-linear distortion. The average power during the burst is reported. Speakers must be able to withstand this level if they are to be safely used with this amplifier.
4. A 40 millisecond burst or two cycles of sine wave (whichever is of greater duration) is used and the power computed as the average power during the burst. The duty cycle of this test is 10 percent. This power level is a measure of how loud an amplifier is as perceived by the hearing process.
5. EIA standard RS-490 (both channels driven).

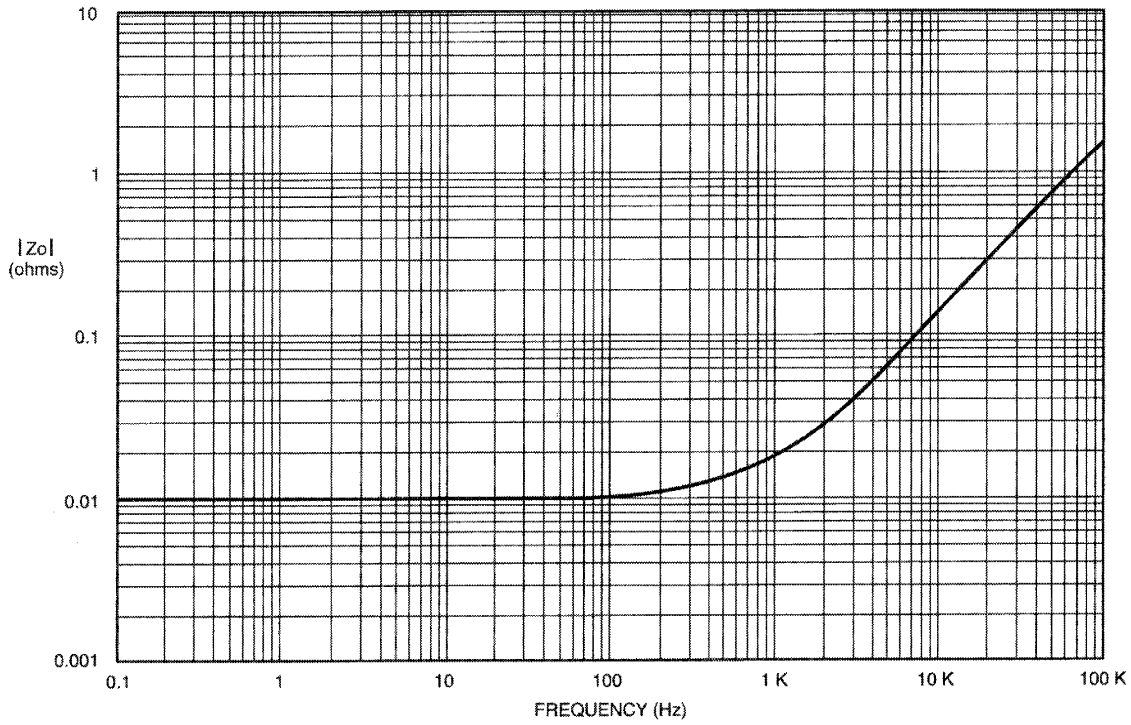

Fig. 7.2 Nominal Output Impedance

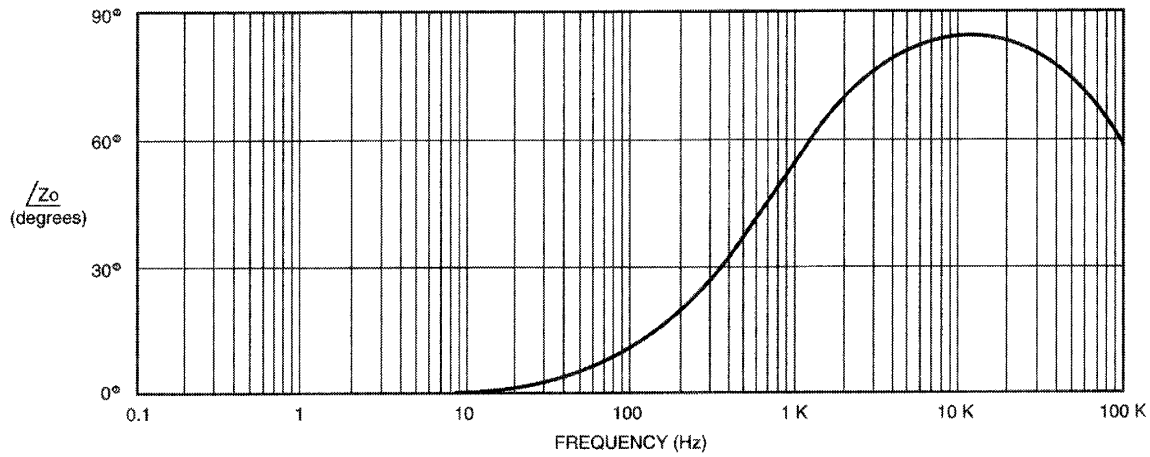

Fig. 7.3 Nominal Output Phase Angle
(1 amp test)

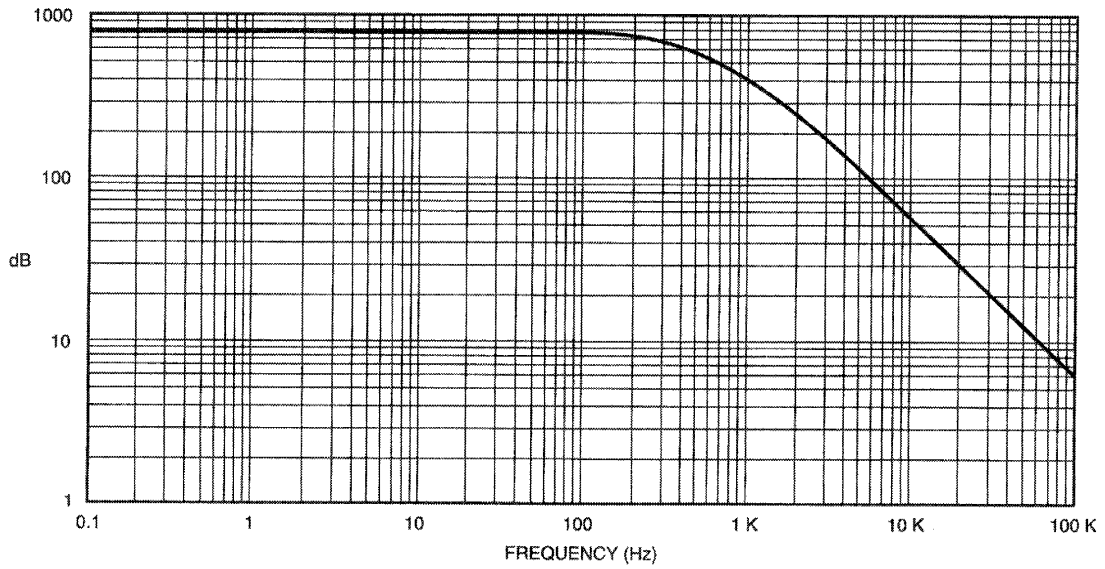

Fig. 7.4 Nominal Damping Factor (8 ohms)

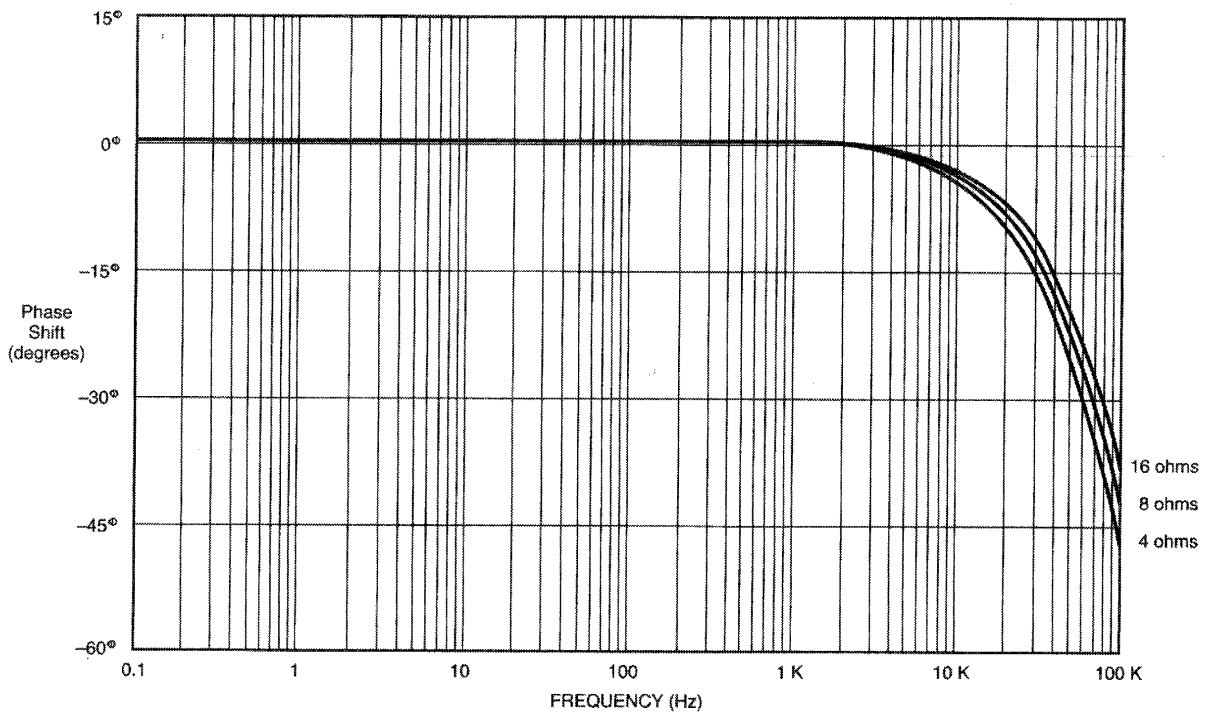
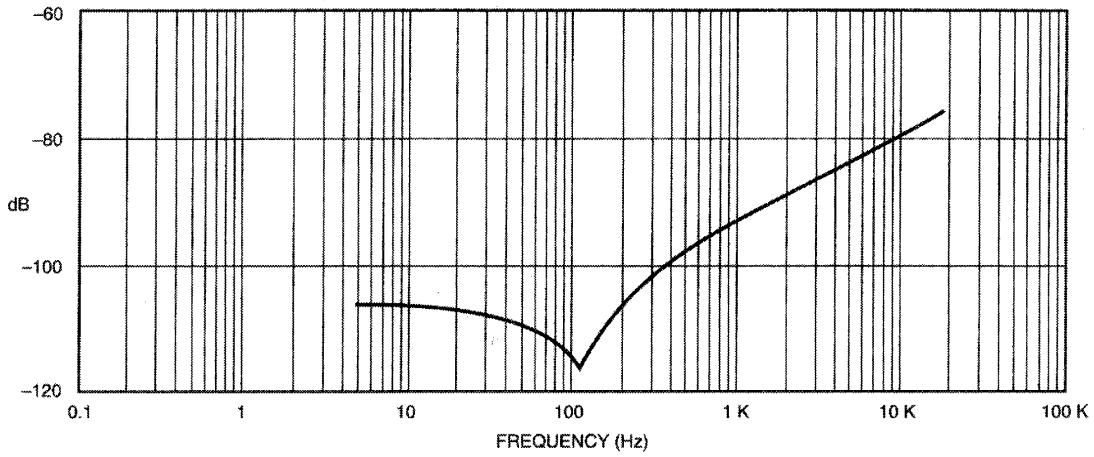
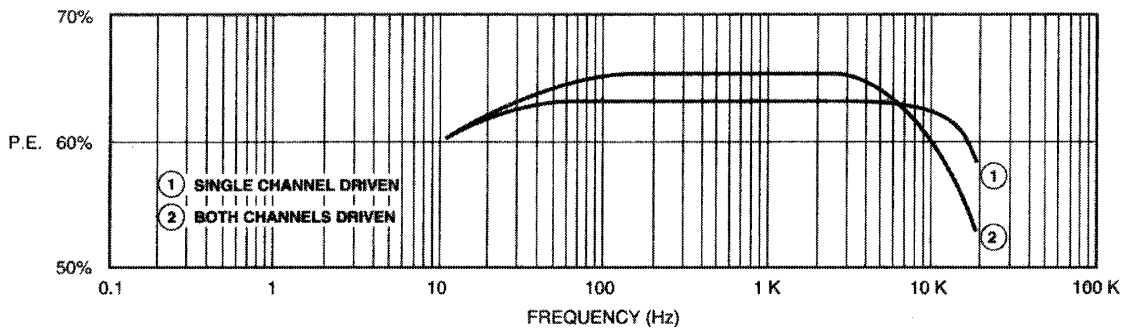

Fig. 7.5 Nominal Phase Response



*Fig. 7.6 Nominal Crosstalk
(75 watts into 8 ohms with one channel driven)*



*Fig. 7.7 Nominal Power Efficiency
(120 VAC line into 8 ohm load)*

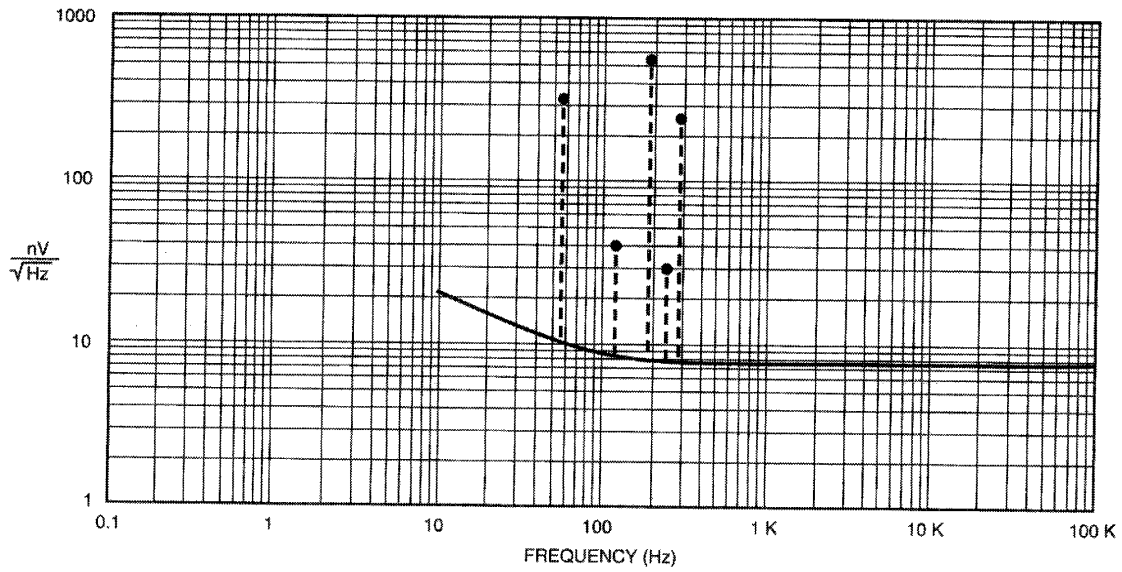

Line frequency harmonics plotted to the fifth order.
Spectrum total is equivalent to 1.25 uV input noise
over a 20 Hz to 20 kHz bandwidth.

Fig. 7.8 Nominal Noise Spectrum

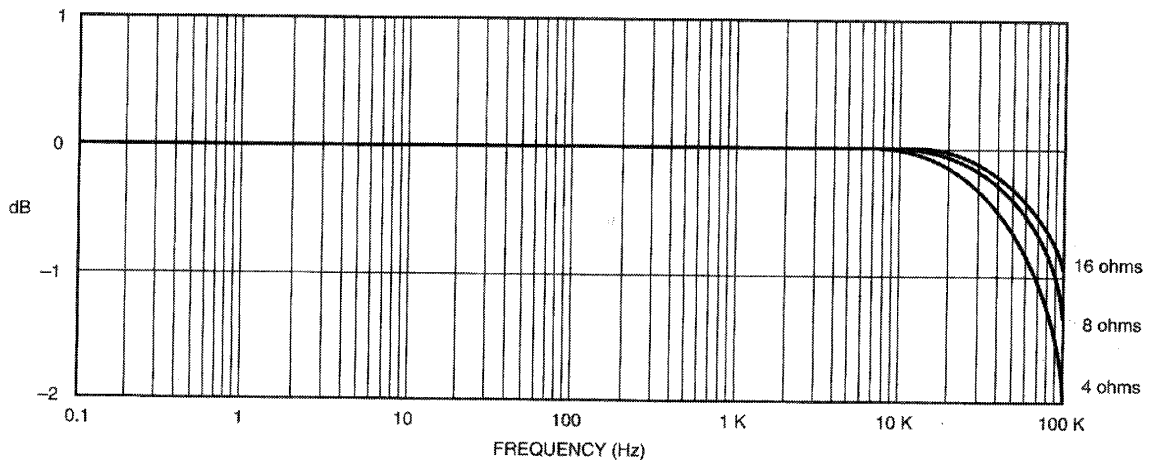

Fig. 7.9 Nominal Frequency Response

8 Options

8.1 0.775 V Input Sensitivity

The D-150A Series II amplifier comes with an optional feature that increases the input sensitivity of the amplifier to allow a 0 dBm (.775 V RMS) input signal to drive the amplifier to full rated power. The feature is set up to be easily field implemented by either a Crown Warranty Service Station or by the user without voiding the warranty.

8.1.1 Modification Instructions

1. Disconnect the amplifier from AC power.
2. Place the amplifier transformer end down on a flat surface. Remove the two black phillips head screws

adjacent to the input jacks. The dress plate and perforated main board cover can now be easily removed. This will expose both sides of the main circuit board.

3. Solder #22 buss wire jumpers at the locations marked R146 and R264 on the main circuit board. A board layout with the jumpers locations indicated is provided for easy reference (Figure 8.1).
4. Reassemble the unit in reverse order of disassembly.

8.1.2 Specification Changes

Stereo Voltage Gain: 21.6:1 $\pm 2\%$ or 26.7 dB ± 0.02 dB.

Monaural Voltage Gain: 43.2:1 $\pm 2\%$ or 32.7 dB ± 0.02 dB.

Input Sensitivity: 0.775 volts $\pm 2\%$ for 80 watts into 8 ohms STEREO or 160 watts into 16 ohms MONO.

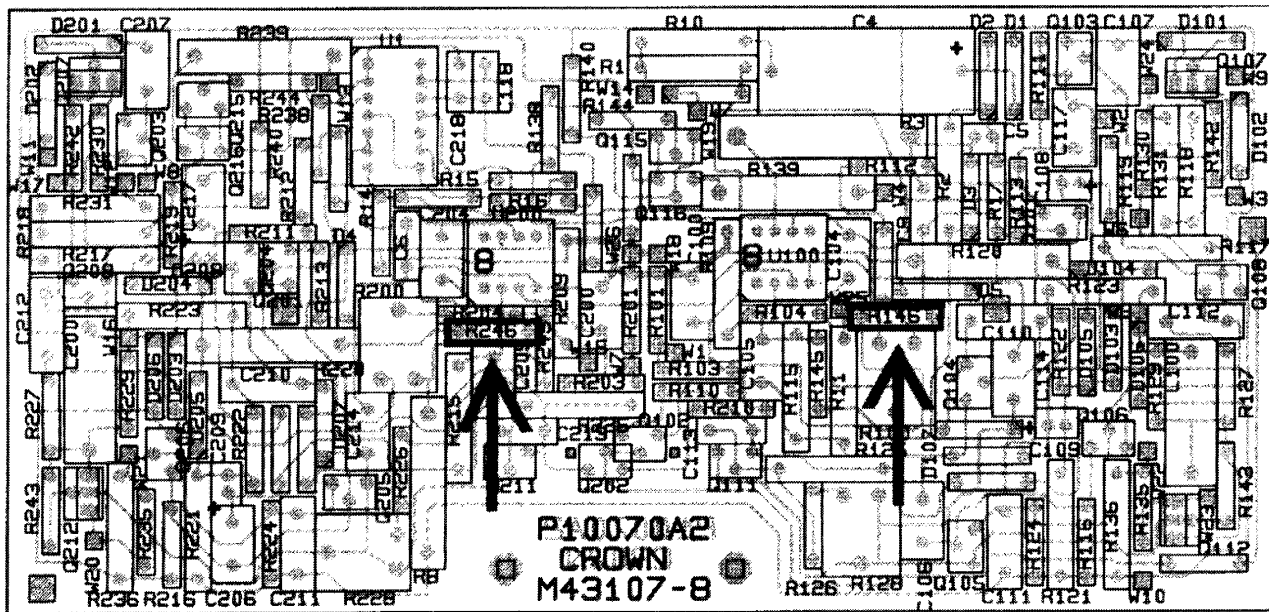

Fig. 8.1 Circuit Block Layout
(0.775 V Input Sensitivity Jumpers)